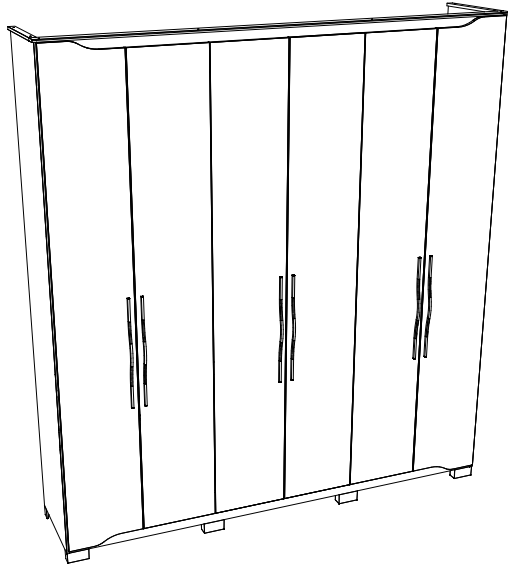
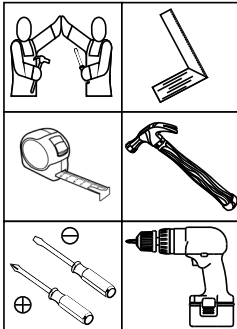

HENNInd. e Com. de Móveis Henn
Mondaiá - SC - Brasil

☎ +55 49 3674.3500

📱 @moveishenn
www.henn.com.br**INSTRUÇÕES DE
MONTAGEM**INSTRUCCIONES DE MONTAJE
ASSEMBLY INSTRUCTIONS**Roupeiro Dallas 6 Portas 4 Gavetas | Armario Dallas 6 Puertas 4 Cajones |
Wardrobe Dallas 6 Doors 4 Drawers****D304-127 Nature/Off White
D304-166 Nature/Cinza****Requisitos para montagem
Requisitos para la montaje
Assembly Requirements**

Imagens meramente ilustrativas,
não acompanha o produto.
Imágenes ilustrativas, no incluidas
con el producto.
Illustrative images, not included
with the product.

AVISO

Para limpeza de seu móvel, use uma flanela seca ou umedecida, e não utilize produtos químicos que possam danificar seu produto.

SISTEMA DE MONTAGEM

O sistema de montagem dos produtos, funciona de acordo com a ordem crescente dos números indicados no desenho. Ex: 01, 02, 03, 04... até a conclusão da montagem.

ASSISTÊNCIA TÉCNICA

Para solicitação de Assistência Técnica você consumidor deverá entrar em contato com o Lojista a qual você realizou a compra deste produto e solicitar a assistência técnica das peças avariadas. A garantia abrange todas as peças, partes e componentes que eventualmente venham apresentar defeito de fabricação no prazo de 03 (três) meses, contando a partir da entrega do produto ao consumidor, mediante nota fiscal de compra. Se houver qualquer alteração na estrutura do produto ou ocorrer defeito por negligência do montador/consumidor em relação a instrução de montagem e manuseio, não será fornecido assistência técnica gratuita.

ADVERTENCIA

Para limpieza de su móvil, use una flanela seca o húmeda, y no utilice productos químicos que puedan dañar su producto.

SISTEMA DE MONTAJE

El sistema de montaje de los productos funciona de acuerdo con el orden creciente de los números indicados en el dibujo. Ej.: 01, 02, 03, 04... hasta la conclusión del montaje.

ASISTENCIA TÉCNICA

Para solicitar Asistencia Técnica, el consumidor debe comunicarse con el Comercio que usted realizó la compra de este producto y solicita asistencia técnica para las partes dañadas. La garantía cubre todas las partes, piezas y componentes que eventualmente puedan presentar defecto de fabricación en el plazo de 03 (tres) meses, contados a partir de la entrega del producto al consumidor, mediante factura de compra. Si se produce algún cambio en la estructura del producto o se produce un defecto por negligencia del montador/consumidor en relación con las instrucciones de montaje y manipulación, no se prestará asistencia técnica gratuita.

NOTICE

To clean your furniture, use a dry or wet cloth, and do not use chemicals that may damage your product.

ASSEMBLY SYSTEM

The products' assembly system works according to the increasing order of the indicated numbers. For example: 01, 02, 03, 04 ... to the end of the assembly.

TECHNICAL ASSISTANCE

To request Technical Assistance, the consumer must contact the retailer from whom you purchased this product and request technical assistance for the damaged parts. The warranty covers all parts, parts and components that may eventually present a manufacturing defect within a period of 03 (three) months, counting from the delivery of the product to the consumer, by means of a purchase invoice. If there is any change in the structure of the product or defect occurs due to negligence of the assembler/consumer in relation to the assembly and handling instruction, free technical assistance will not be provided.

ACESSÓRIOS | ACCESORIOS | ACCESSORIES

A



x8

B



x30

C



x16

D



x24

E



x8

F



x128

G



x64

H

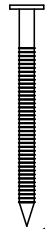

x8

I



x139

J

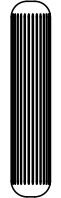

x88

K

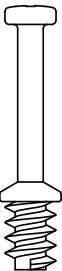

x2

L

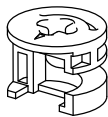

x2

M



x16

N



x40

O

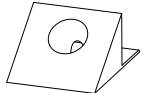

x8

ACESSÓRIOS | ACCESORIOS | ACCESSORIES

P

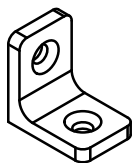

x20

Q



x8

R

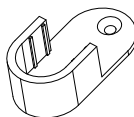

x4

S

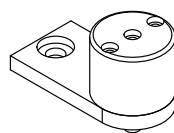

x16

T

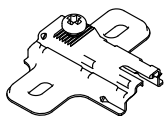

x24

U

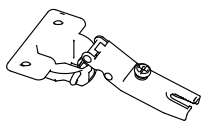

x24

V

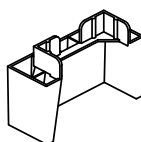

x8

W

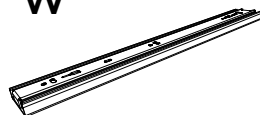
x4^{PAR}

X



x2

Y



x3

Z



x6

AA



x2

AB

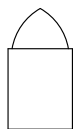

x3

AC

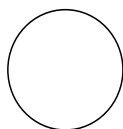

x4

AD



x56

AE



x1

AF

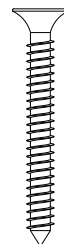

x8

LISTA DE PEÇAS | LISTA DE PIEZAS | LIST OF PIECES ITM/D304-

Item	Caixa Caja Box	Qty Ctd Qty	Descrição Descripción Description	Dimensões (mm) Dimensiones (mm) Dimensions (mm)		
				Comprimento Largo Length	Largura Ancho Width	Espesura Grosor Thickness
1	2/3	1	RODAPÉ FRONTAL FALDÓN DELANTERO FRONT SKIRTING	2076	100	12
2	2/3	2	TRAVESSA DO RODAPÉ PLACA DE RODAPIÉ SKIRTING PLATE	415	100	12
3	2/3	1	RODAPÉ TRASEIRO REPOSAPIÉS TRASERO BACK FOOT-BOARD	2076	100	12
4	2/3	1	BASE BASE BASE	2076	445	12
5	2/3	1	LATERAL ESQUERDA LATERAL IZQUIERDA LEFT SIDE	2238	445	12
6	1/3	1	DIVISÃO ESQUERDA DIVISIÓN IZQUIERDA LEFT DIVISION	1667	445	12
7=14	1/3	1	TAMPO DAS GAVETAS TAPA DE LOS CAJONES TOP OF DRAWERS	684	400	12
8	1/3	1	DIVISÃO DIREITA DIVISIÓN DERECHA RIGHT DIVISION	1667	445	12
9	2/3	3	PRATELEIRA ESTANTE SHELF	684	350	12
10	2/3	1	CHÃO DO MALEIRO REPISA SUPERIOR FLOOR OF MALEIRO	2076	445	12
11	2/3	2	RIPA DO MALEIRO TRAVESAÑO SUPERIOR MALEIRO'S LATH	350	73	12
12	2/3	1	TAMPO TAPA TOP	2076	433	12
13	2/3	1	LATERAL DIREITA LADO DERECHO RIGHT SIDE	2238	445	12
14=7	1/3	1	TAMPO DAS GAVETAS TAPA DE LOS CAJONES TOP OF DRAWERS	684	400	12
15	2/3	1	FUNDO SUPERIOR FONDO TOP TOP FUND	2094	367	3
16	1/3	6	FUNDO FONDO BOTTOM	1685	348	3
17	2/3	1	CHAPÉU SOMBRERO HAT	2076	97	12
18	3/3	2	PORTA LATERAL PUERTA LATERAL SIDE DOOR	2217	345	15
19	3/3	4	PORTA PUERTA DOOR	2143	345	15
20	2/3	1	MOLDURA FRONTAL CORNIJA FRONTAL FRONT FRAME	2120	60	12
21	2/3	2	MOLDURA LATERAL MARCO LATERAL LATERAL FRAME	408	30	12
22	1/3	4	RIPA DE TRÁS MALLA DETRÁS REAR LATH	614	110	12
23	1/3	8	LADO DE GAVETA LADO DEL CAJÓN SIDE OF DRAWER	350	110	12
24	1/3	4	FUNDO DE GAVETA RECORTADO FONDO DEL CAJÓN RECORTADO CROPPED DRAWER BOTTOM	601	361	3
25	2/3	4	FRENTE DE GAVETA FRENTE DE CAJÓN FRONT OF DRAWER	626	152	12

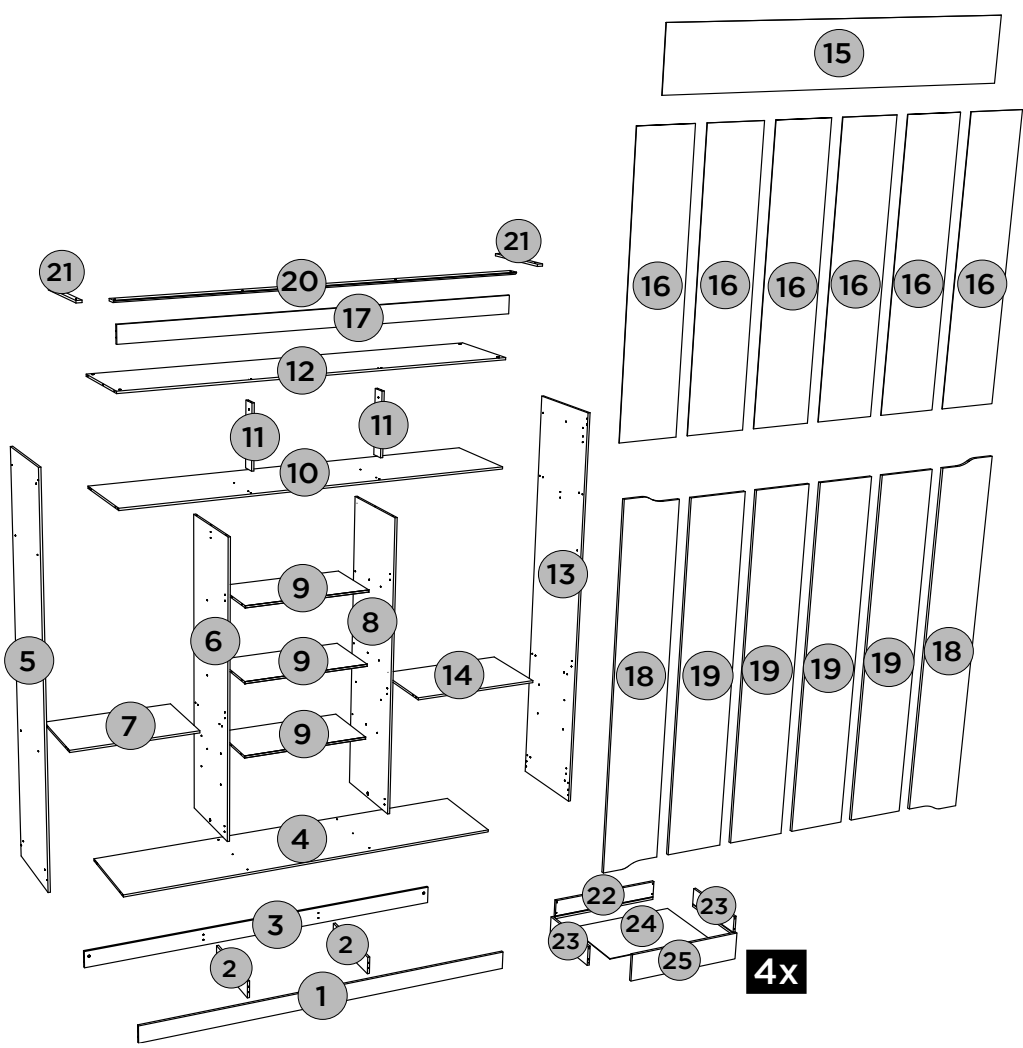





4x

PEÇAS REQUERIDAS

1	RODAPÉ FRONTAL	x1
2	TRAVESSA DO RODAPÉ	x2
3	RODAPÉ TRASEIRO	x1
11	RIPA DO MALEIRO	x2
17	CHAPÉU	x1

ACESSÓRIOS REQUERIDOS

F		04
J		18
P		04
Q		04

FERRAMENTAS NECESSÁRIAS

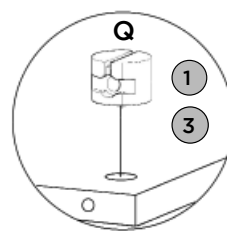
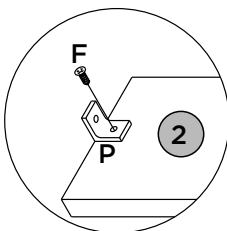
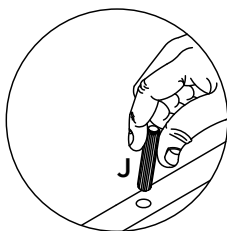
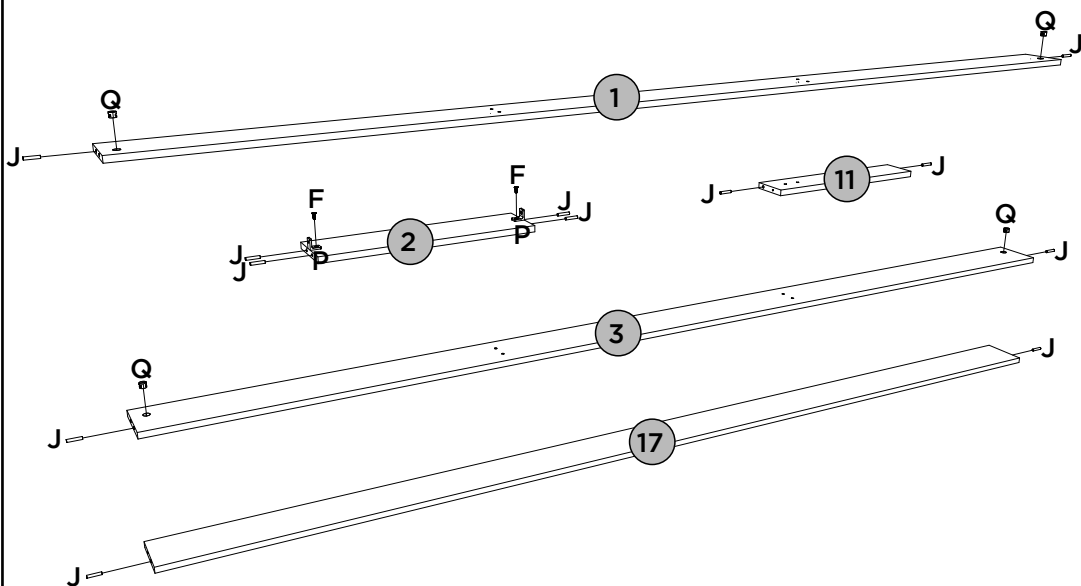
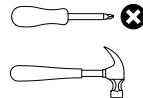

PASSO 2

ITM/D304-

PEÇAS REQUERIDAS

4	BASE	x1
5	LATERAL ESQUERDA	x1
6	DIVISÃO ESQUERDA	x1
7=14	TAMPO DAS GAVETAS	x2
9	PRATELEIRA	x3

ACESSÓRIOS REQUERIDOS

F		16
G		04
J		28
K		02
R		02
S		08
T		04

FERRAMENTAS NECESSÁRIAS

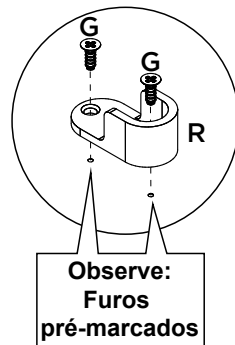
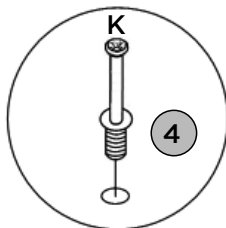
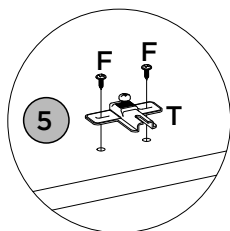
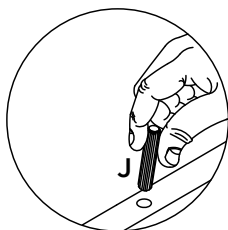
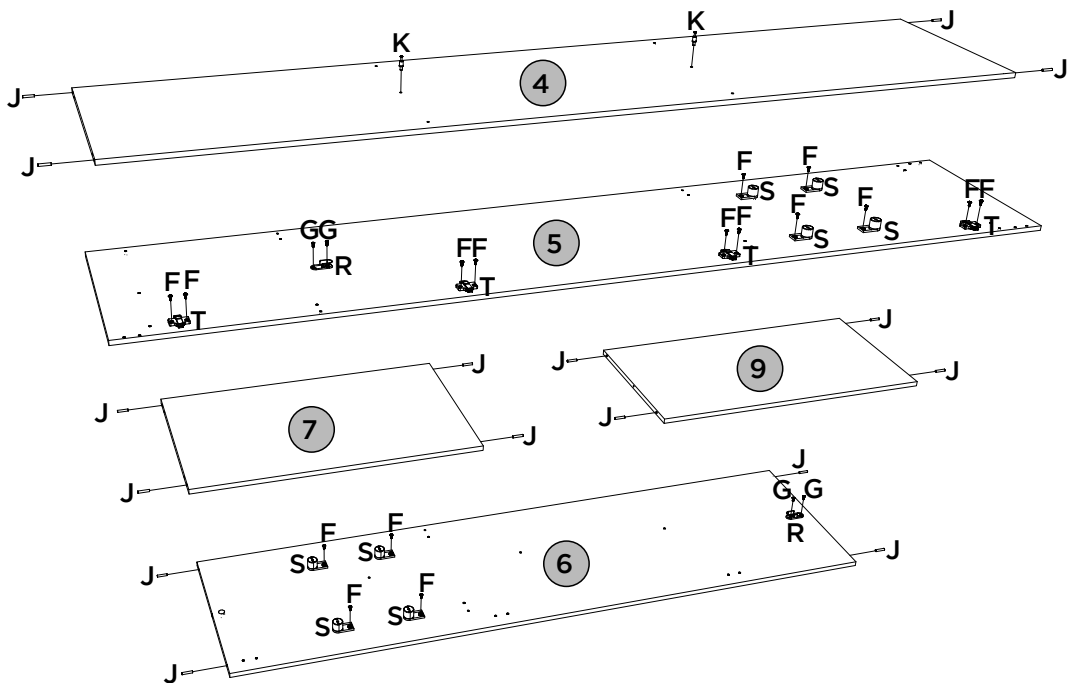
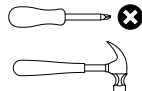

**Observe:
Furos
pré-marcados**

PEÇAS REQUERIDAS

8	DIVISÃO DIREITA	x1
10	CHÃO DO MALEIRO	x1
12	TAMPO	x1
13	LATERAL DIREITA	x1

ACESSÓRIOS REQUERIDOS

F		16
G		04
J		10
Q		04
R		02
S		08
T		04

FERRAMENTAS NECESSÁRIAS

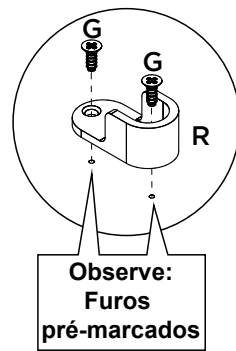
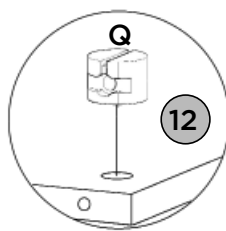
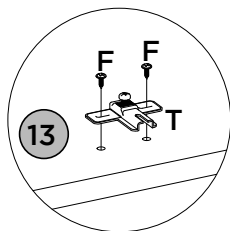
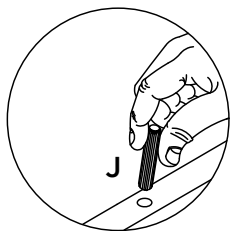
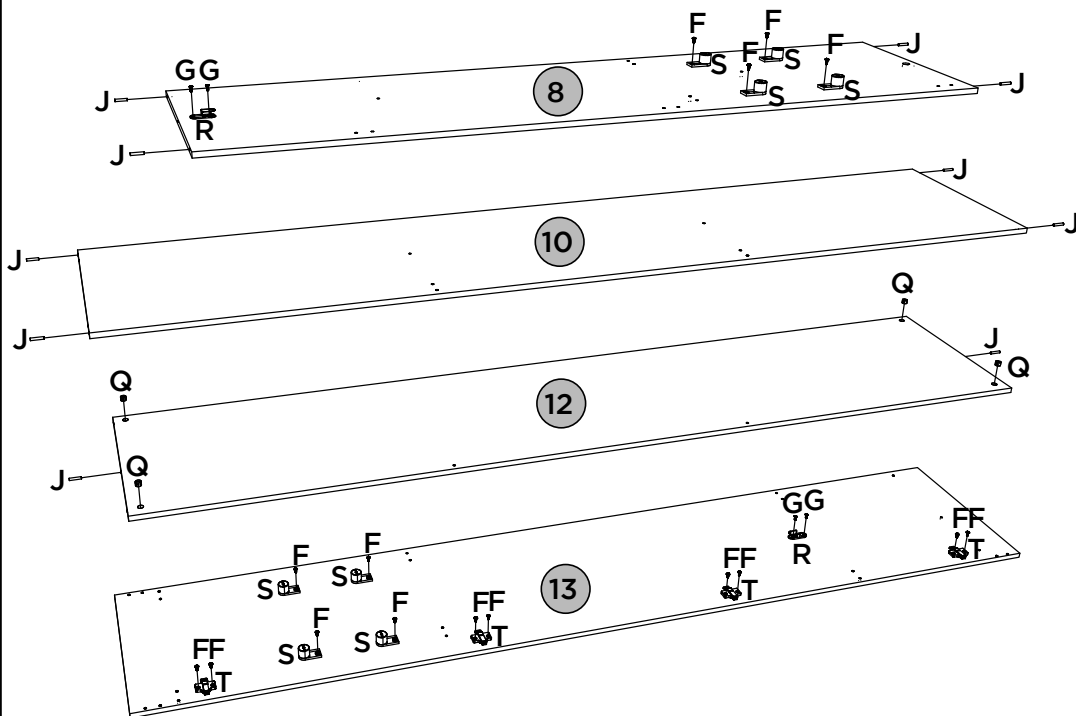
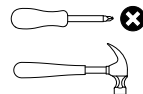

Observe:
Furos
pré-marcados

PASSO 4

ITM/D304-

PEÇAS REQUERIDAS

1	RODAPÉ FRONTAL	x1
2	TRAVESSA DO RODAPÉ	x2
3	RODAPÉ TRASEIRO	x1

ACESSÓRIOS REQUERIDOS





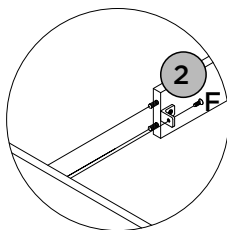
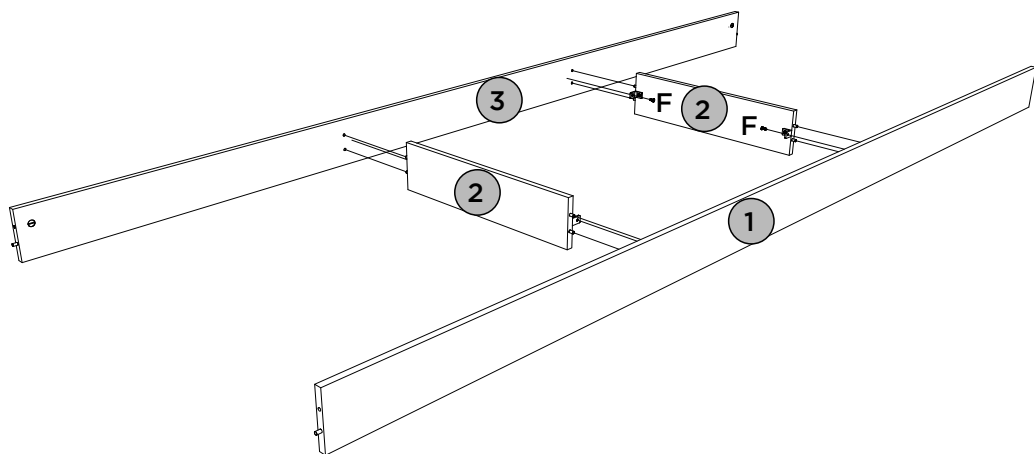
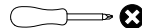



FERRAMENTAS NECESSÁRIAS



PEÇAS REQUERIDAS

4	BASE	x1
5	LATERAL ESQUERDA	x1
6	DIVISÃO ESQUERDA	x1
7	TAMPO DAS GAVETAS	x1

ACESSÓRIOS REQUERIDOS

A		02
B		06
F		36
L		01
P		06
V		08

FERRAMENTAS NECESSÁRIAS

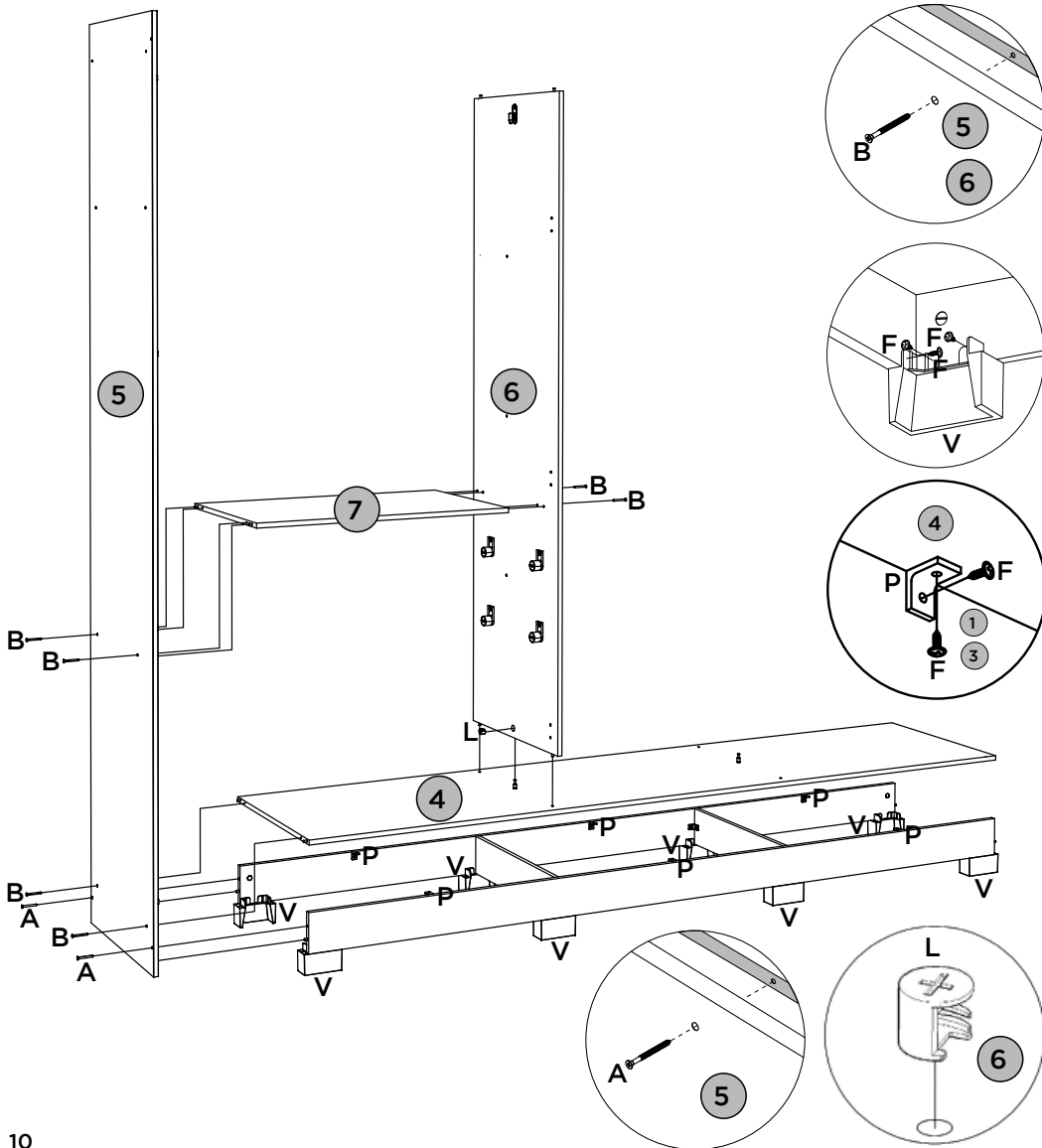
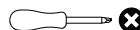



PASSO 6

ITM/D304-

PEÇAS REQUERIDAS

8	DIVISÃO DIREITA	x1
9	PRATELEIRA	x3

ACESSÓRIOS REQUERIDOS

B		06
L		01

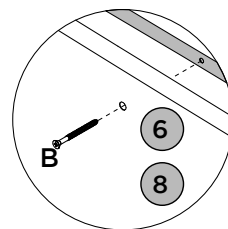
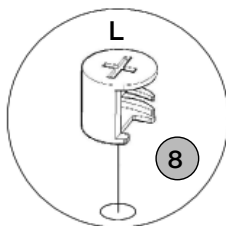
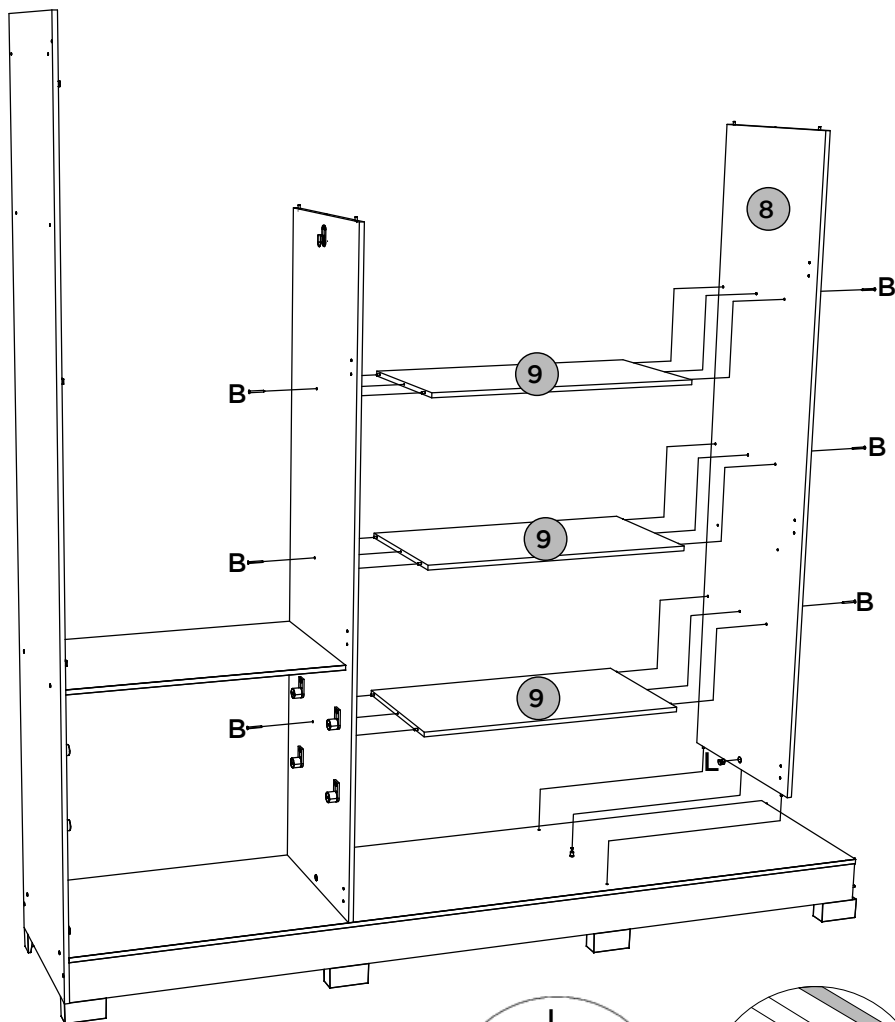
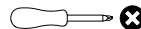

FERRAMENTAS NECESSÁRIAS



PEÇAS REQUERIDAS

10	CHÃO DO MALEIRO	x1
11	RIPA DO MALEIRO	x2
12	TAMPO	x1
13	LATERAL DIREITA	x1
14	TAMPO DAS GAVETAS	x1

ACESSÓRIOS REQUERIDOS

A		06
B		16



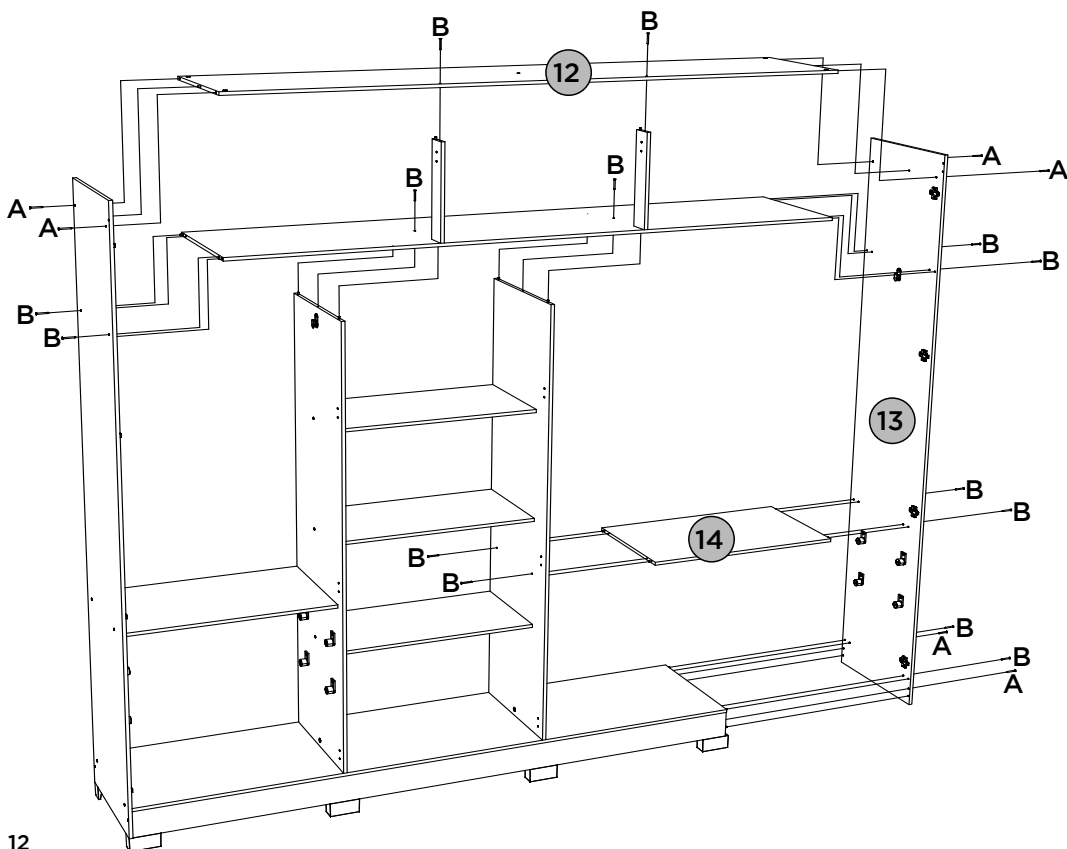
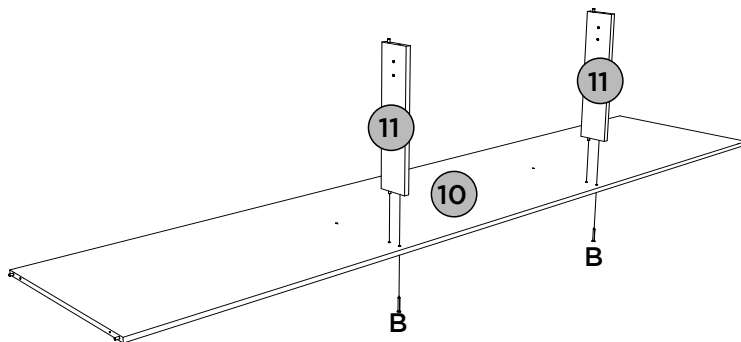
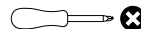



FERRAMENTAS NECESSÁRIAS



PEÇAS REQUERIDAS

15	FUNDO SUPERIOR	x1
16	FUNDO	x6
17	CHAPÉU	x1

ACESSÓRIOS REQUERIDOS

B		02
F		04
I		139
N		40
P		02
Y		03

FERRAMENTAS NECESSÁRIAS

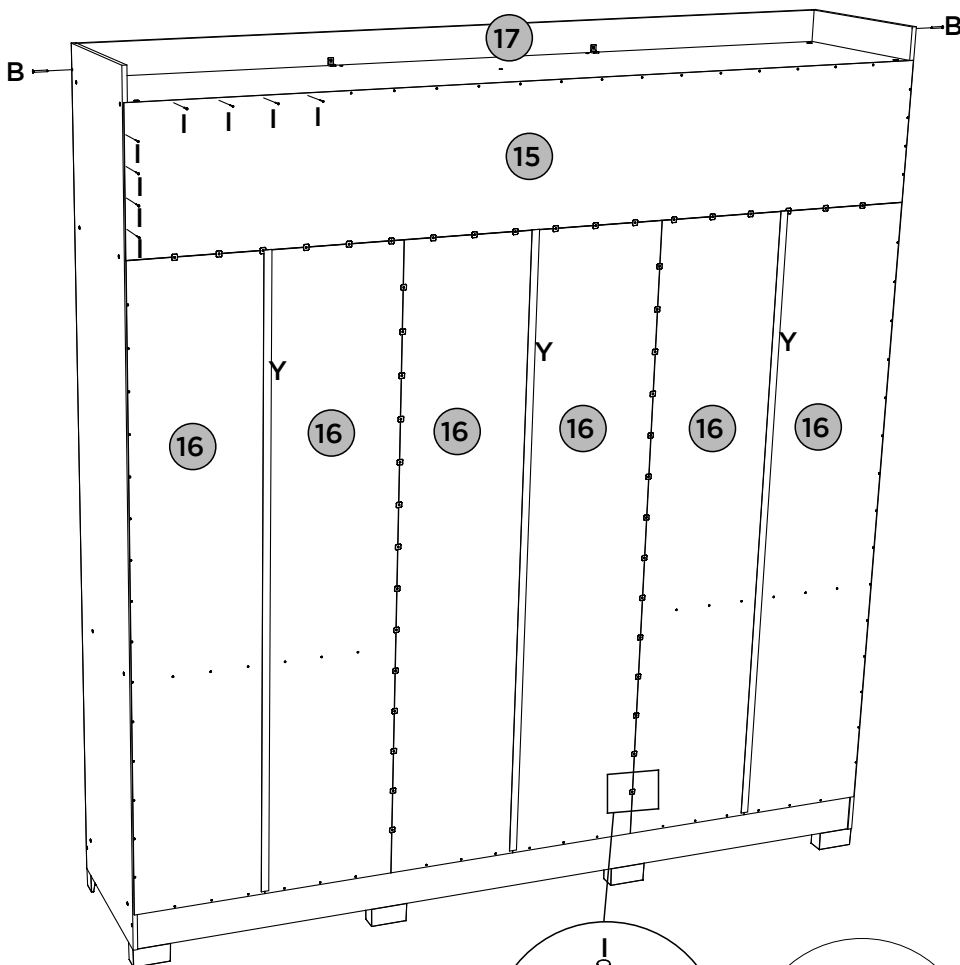
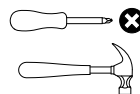

Fixar os pregos a uma distância de 120mm de um para outro.

Fijar las uñas a un distancia de 120mm uno a otro.



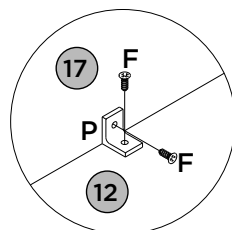
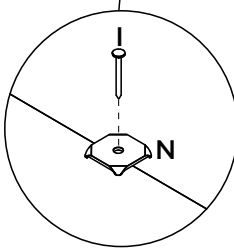

Fix the nails at a distance of 120mm from one to the other



PEÇAS REQUERIDAS

18	PORTA LATERAL	x2
19	PORTA	x4

ACESSÓRIOS REQUERIDOS

D		24
F		48
U		24
Z		06

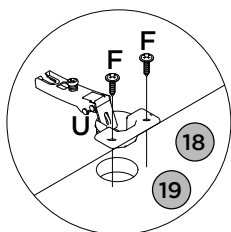
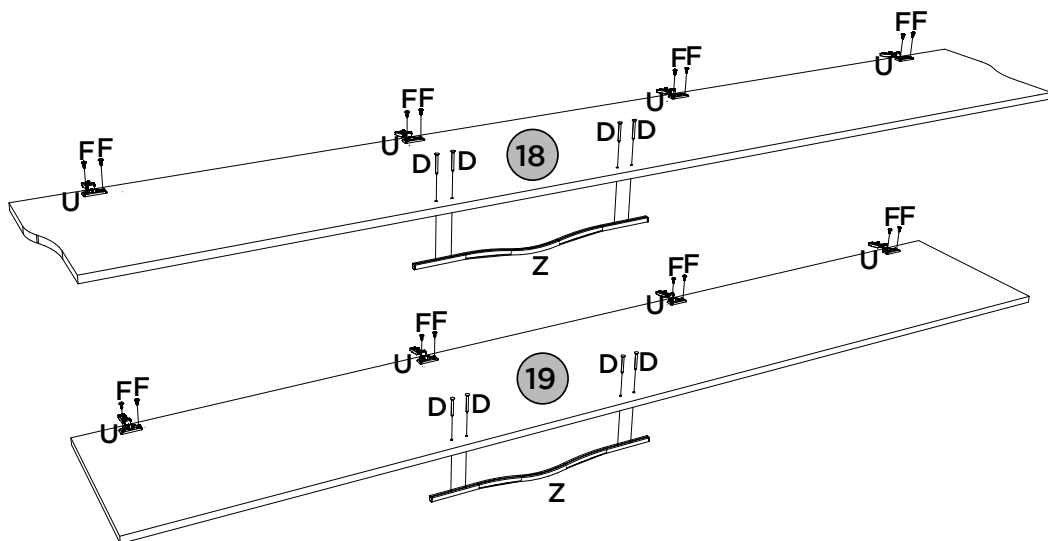
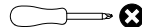
FERRAMENTAS NECESSÁRIAS

Vídeo: Instalar e regular Dobradiças

Video: Instale y ajuste las bisagras

Video: Install and adjust hinges

PEÇAS REQUERIDAS

18	PORTA LATERAL	x2
19	PORTA	x4
20	MOLDURA FRONTAL	x1
21	MOLDURA LATERAL	x2

ACESSÓRIOS REQUERIDOS

C		16
G		16
M		16
T		16
W		04
X		02
AF		08

FERRAMENTAS NECESSÁRIAS

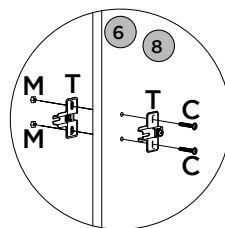
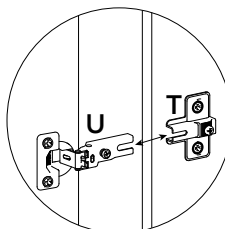
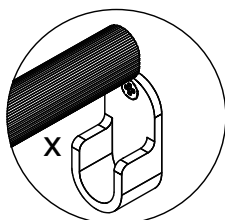
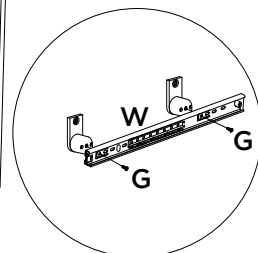
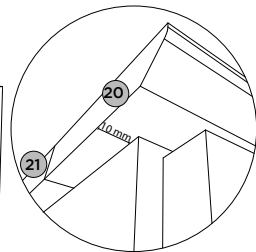
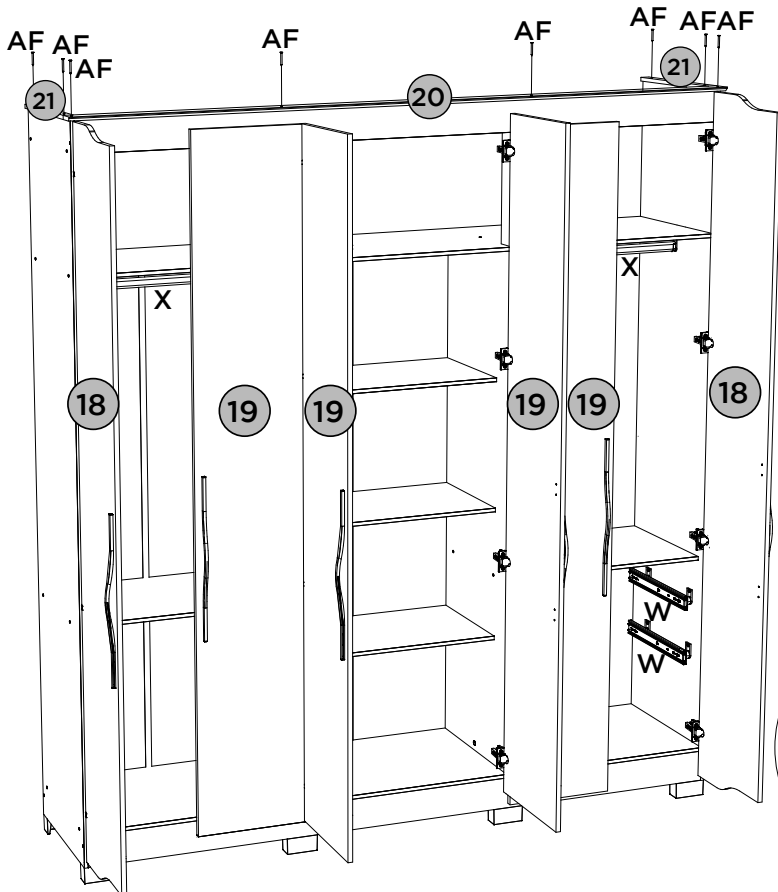
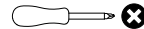



PASSO 11

ITM/D304-

PEÇAS REQUERIDAS

23	LADO DE GAVETA	x8
----	----------------	----

ACESSÓRIOS REQUERIDOS

J		32
AA		

FERRAMENTAS NECESSÁRIAS

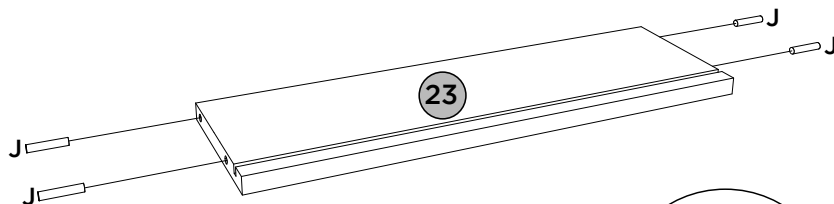
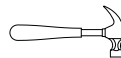

PASSO 12

PEÇAS REQUERIDAS

22	RIPA DE TRÁS	x4
23	LADO DE GAVETA	x8

ACESSÓRIOS REQUERIDOS

AA		
----	---	--

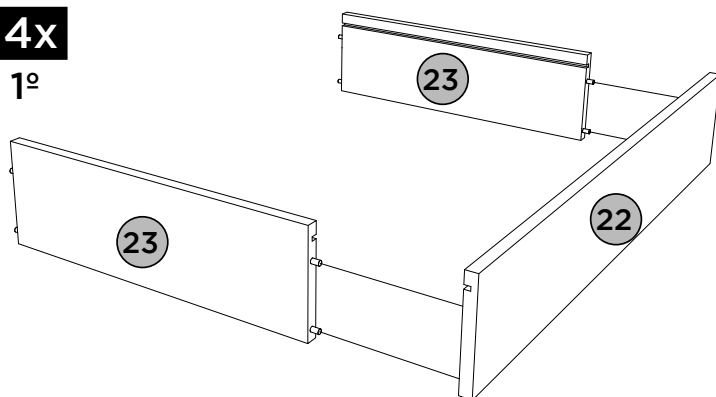

4x
1º



PEÇAS REQUERIDAS

24	FUNDO DE GAVETA RECORTADO	x4
25	FRENTE DE GAVETA	x4

ACESSÓRIOS REQUERIDOS

H		08
AA		

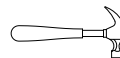
FERRAMENTAS NECESSARIAS

4x

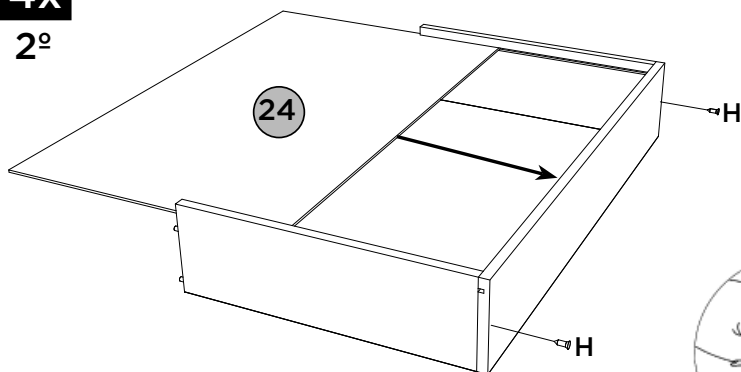



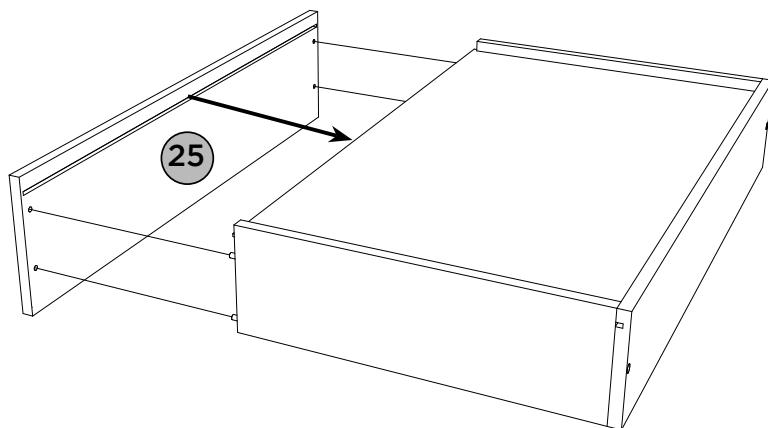

2º

4x

3º



ACESSÓRIOS REQUERIDOS

E			08
G			40
O			08
P			08
W			04

FERRAMENTAS NECESSÁRIAS

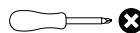

4x

4º

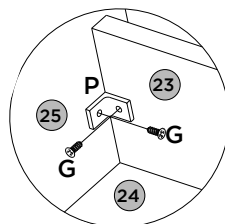
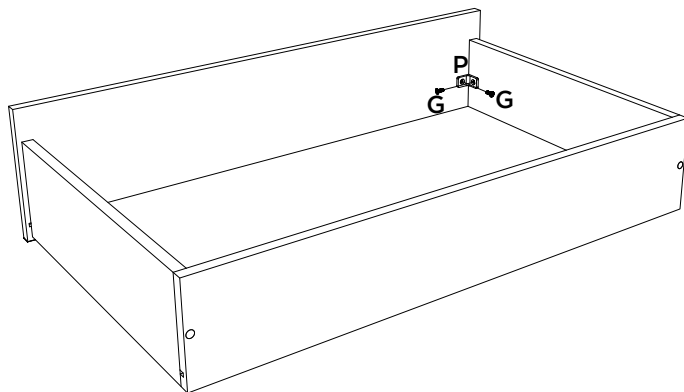

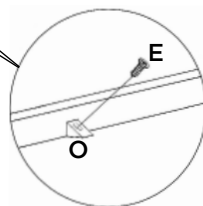
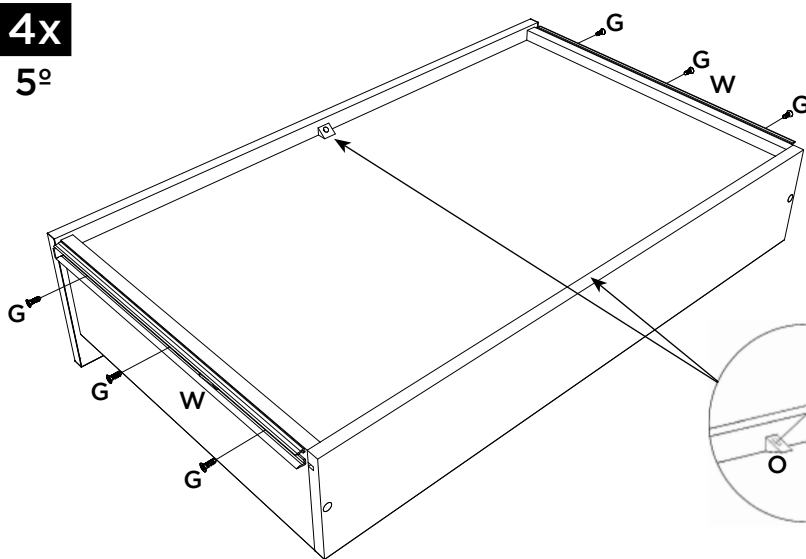

4x

5º



ACESSÓRIOS REQUERIDOS

AB		03
AC		04
AD		56
AE	HENN	01

Pesos máximos recomendados com carga distribuída
 Peso máximo recomendado con la carga distribuida
 Recommended maximum weight with distributed load.

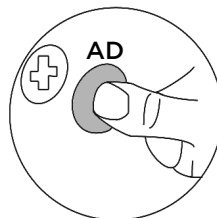
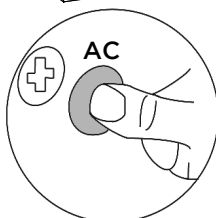
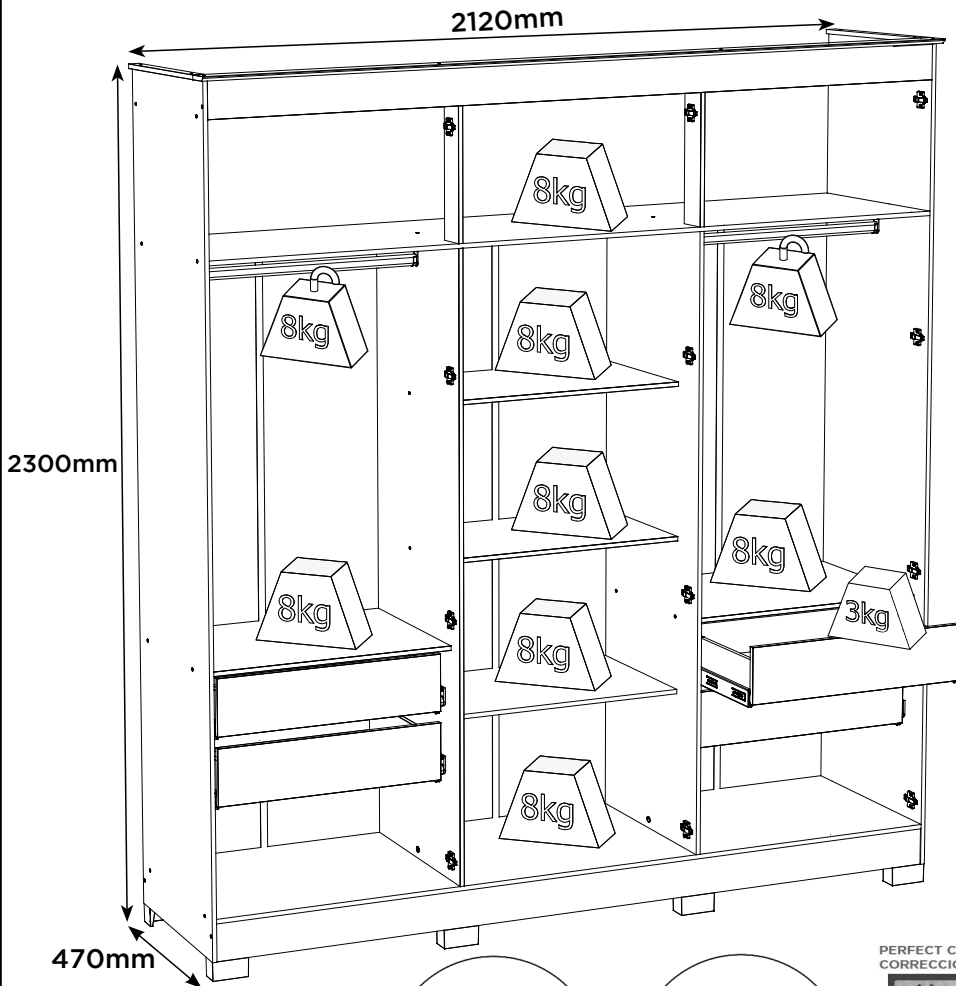

PERFECT CORRECTION
 CORRECCIÓN PERFECTA

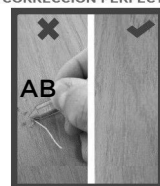

Produto Concluído
Producto terminado
Finished Product

